

# emco installation frame 500 Chrome-nickel steel (V2A)

## Model 500-25 CN

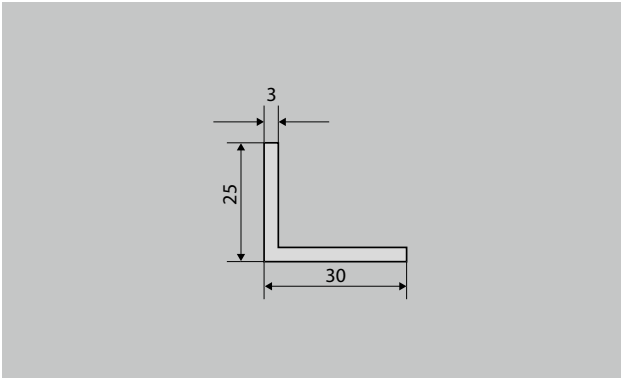

### Description

The emco installation frame 500 consists of angled profiles with mitred corners. The sturdy gusset plates supplied ensure a screw connection that is true to size. The scope of delivery includes wall anchors; stainless steel versions for use in wet areas are available on request. The frame is supplied either ready for assembly or pre-assembled (e.g. in the case of frames with curved sections or several sections, etc.).



Outside  
(Zone 1)



Indoor and  
outdoor (co-  
vered, Zone  
1+2)

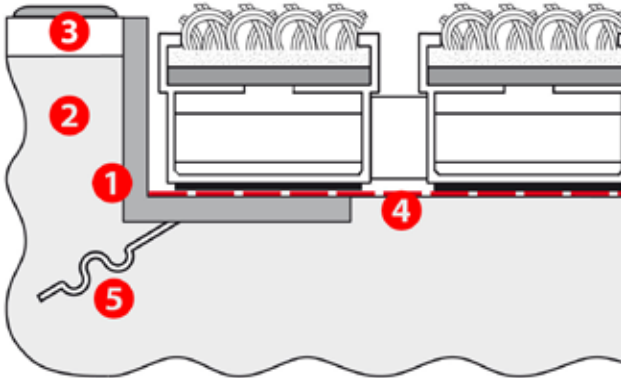

## emco installation frame 500 Chrome-nickel steel (V2A)

---

### Model 500-25 CN

<b>Description</b>	The emco installation frame 500 consists of angled profiles with mitred corners. The sturdy gusset plates supplied ensure a screw connection that is true to size. The scope of delivery includes wall anchors; stainless steel versions for use in wet areas are available on request. The frame is supplied either ready for assembly or pre-assembled (e.g. in the case of frames with curved sections or several sections, etc.).
<b>Approx. material thickness (mm)</b>	3,0
<b>Installation guide</b>	The frame (1) must be flush with both the screed (2) in the mat well and the floor covering (3). Mat and mat well: The mat well base (4), which is usually screed, must be completely level. Any unevenness in the mat well must be smoothed out before the mat is laid. In such cases we recommend using a liquid levelling compound. The frame anchor (5) is cast in the screed.
<b>Model</b>	500-25 CN

Subject to technical modifications

emco Bautechnik GmbH · Breslauer Straße 34 - 38 · D-49808 Lingen (Ems)  
· Germany · Phone: +49 (0) 591/9140-500 · Fax: +49 (0) 591/9140-852 · Email:  
bau@emco.de · www.emco-bau.com

