

Model A17

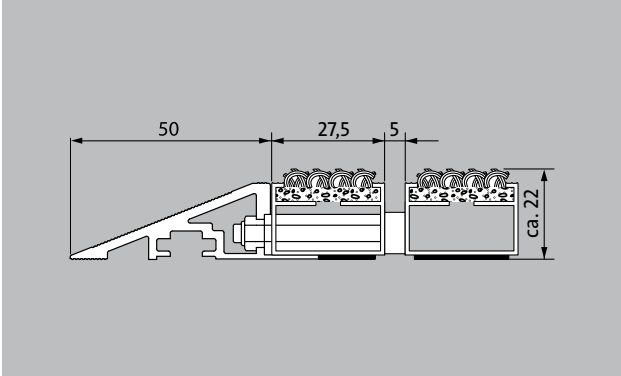

Description

The ramp edge bevel guarantees trip-free access onto the mat. For DIPLOMAT entrance mats (heights 12, 17 and 22 mm) mounted on finished floors at ground level. With profiled tread surface. Material: Aluminium. This design can be installed on 1, 2, 3 or 4 sides at a 90° angle.



Outside
(Zone 1)



Indoor and
outdoor (co-
vered, Zone
1+2)



Model A17

Technical details	Versions: installed 1-side along the width, 2-sided along the width or all round
Approx. material thickness (mm)	1,5

Height (mm)	17
Normmatte H x B x T in mm	nicht verfügbar

Subject to technical modifications