

Model 723/35

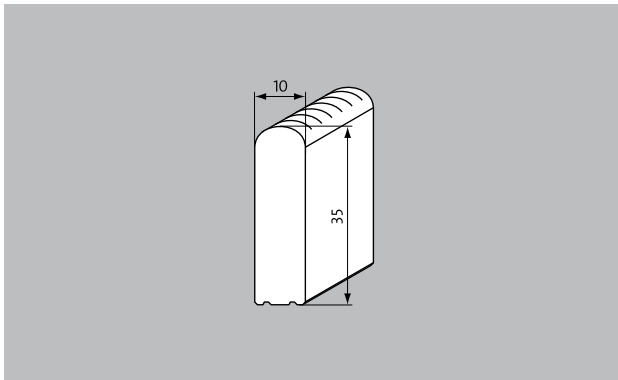

Description

Swimming pool grating that is robust, solid and pleasant to walk on, which efficiently collects the overflow water at the edge of the pool and provides maximum safety and hygiene.



Non-slip properties in acc. with DIN 51097, classification C, angle of inclination $\geq 24^\circ$



Colours



White - similar to RAL 9010



Grey - similar to RAL 7001



Beige - similar to RAL 1001

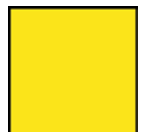

Yellow - similar to RAL 1018



Model 723/35

Profile run	Roll-up swimming pool grating with grating bars running at right angles to the pool edge
Material	High quality, extremely hard-wearing plastic, with UV absorber. Entirely corrosion-free and resistant to chlorine, sea water and spa water. No need for any metal parts; surface enclosed on all sides to provide maximum hygiene.
Support chassis	Full profile (35 x 10 mm)
Finish	Round upper profile surface with safety profile seal (SPS).
Profile spacing:	< 8 mm in accordance with DIN EN 13451-1 and DIN EN 16582-1 (to prevent areas where fingers could become trapped)
Height (mm)	35
Connection	Flexible PUR cord with interim spacer
Slip resistance	Non-slip in accordance with DIN 51097, classification C - tested by the „Institut der Säurefließner-Vereinigung“ (Säurefließner consortium)
Variable grating width (mm)	100-500
Usage area	Public and private swimming pools with overflow channels Whirlpools with overflow channels
Dimensions	Produced to fit width and depth perfectly without the need for alignment profiles
During the winter season	When not in use, the swimming pool gratings (if they are being used in open-air swimming pools) should be put into storage and covered with suitable protection to prevent unnecessary damage and soiling.
Properties	Excellent water drainage Easy to use Easy to clean Custom application options Freedom to create your own concept thanks to the additional special shapes on offer

Accessories

Mitred corner, self-supporting
Fan corner (135° - 179°)
Rigid corner (90°)
Angled profiles with dimensions of 25 x 28 x 3 mm or 28 x 25 x 3 mm suitable for swimming pool gratings with construction heights of 22 and 25 mm. For straight profiles only.
Blue signs in size XL (logo: 150 x 590 mm) with rounded corners and white engraved typeface. The signs are recessed flush with the surface of the swimming pool grate by milling and securely attached to the grate.
Blue signs in size M (pictogram: 150 x 150 mm or logo: 150 x 295 mm) with rounded corners and white engraved typeface. The signs are recessed flush with the surface of the swimming pool grate by milling and securely attached to the grate.
Pre-assembled version with angled profile dimensions of 25 x 28 x 3 mm or 28 x 25 x 3 mm suitable for swimming pool gratings with construction heights of 22 and 25 mm. For straight profiles only.
Mitred corner, self-supporting
Fan corner (135° - 179°)
Rigid corner (90°)
Blue signs in size M (pictogram: 150 x 150 mm or logo: 150 x 295 mm) with rounded corners and white engraved typeface. The signs are recessed flush with the surface of the swimming pool grate by milling and securely attached to the grate.
Blue signs in size XL (logo: 150 x 590 mm) with rounded corners and white engraved typeface. The signs are recessed flush with the surface of the swimming pool grate by milling and securely attached to the grate.

Important information:

General information:

On ceramic low-noise channels, this type of grating may only be used in its rigid design (with plastic threaded rods as the connecting element).

Service and services

Dimensioning

Installation service

Repairs

Subject to technical modifications/Colours may deviate due to production processes