

type 522 P Maximus Image

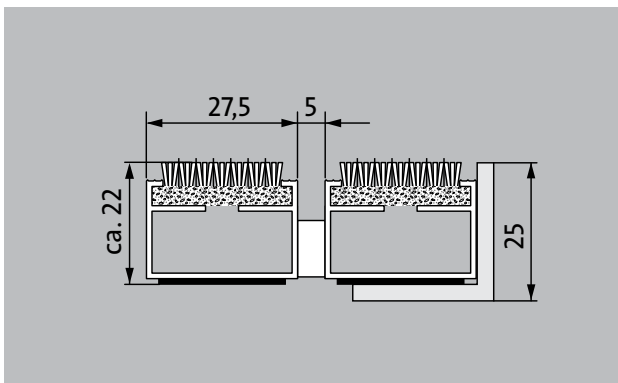
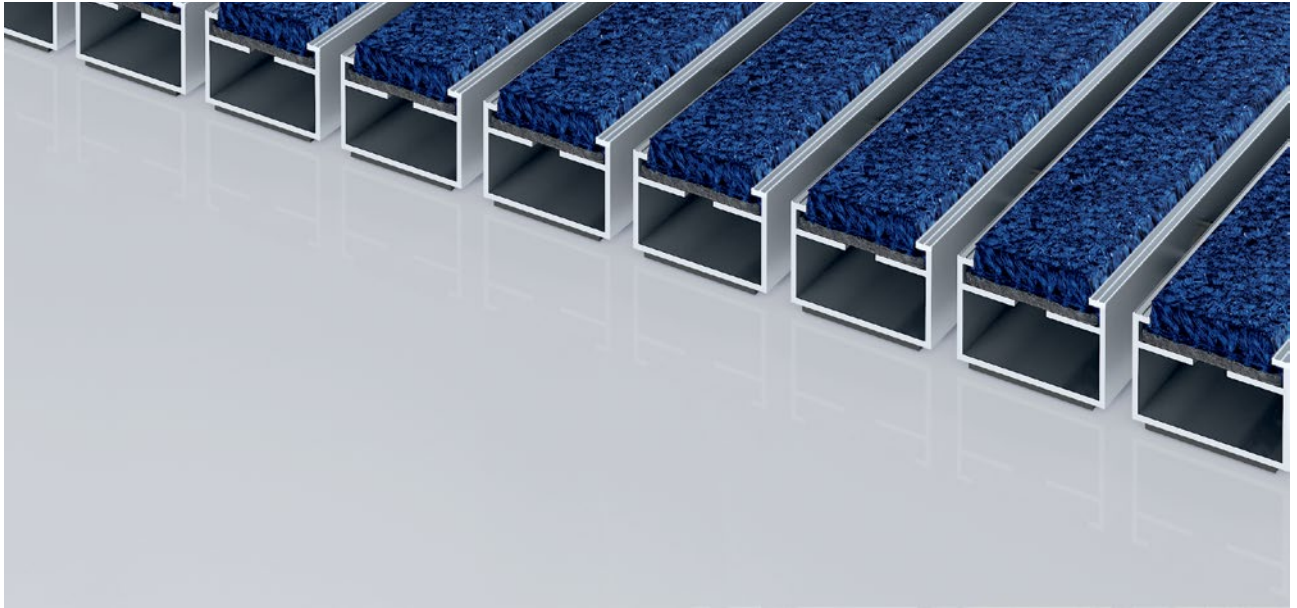

De uiterst slijtvaste Premium entreemat met Maximus Image inlage. Het is mogelijk om de inlage in uw gewenste kleur te printen. Uitermate geschikt voor de opname van fijn vuil. Speciaal voor gebouwen met een normale belastingsfrequentie.

1 **2** **3** Binnen en buiten (overdekt, zone 1+2)

beschrijving

Oprolbare, uiterst slijtvaste Premium entreemat met kwalitatief hoogwaardige inlage. Het is tevens mogelijk om de inlage van uw gewenste kleur te voorzien. Geschikt voor opvallende toepassing. Wordt op maat gemaakt en is in alle vormen leverbaar.



Binnen en buiten (overdekt, zone 1+2)



straatvuil, haren, zand, as, textielvezels, kleine bladeren en takjes enz.



vochtig straatvuil, vochtig zand, stof enz.



slipvaste eigenschap R12 conform DIN 51130



5 jaar garantie



Brandgedrag (EN 13501-1): Bfl-s1



Klasse 33

type 522 P Maximus Image

Kleuren



I10 citroen



I20 geel



I30 geel/oranje

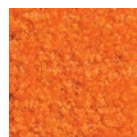

I40 oranje



I50 terracotta



I60 rood



I70 roestrood

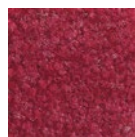

I80 bordeaux



I90 lichtrood

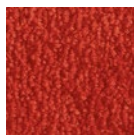

I100 kers

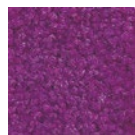

I110 lila

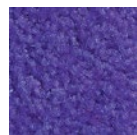

I120 seringen



I130 paars



I140 magenta



I150 perzik

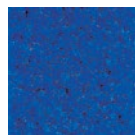

I160 blauw

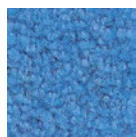

I170 hemels-
blauw

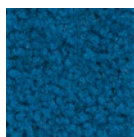

I180 petrol

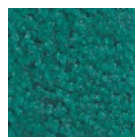

I190 smaragd

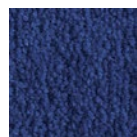

I200 marine



I210 donker-
groen



I220 mint



I230 hardgroen



I240 lichtgroen



I250 groen



I260 bruin

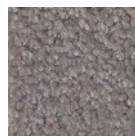

I270 grafiet

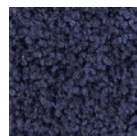

I280 staalblauw

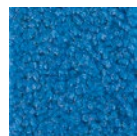

I290 lichtblauw

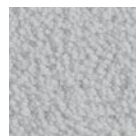

I300 zilver



I310 reebruin



I320 zand

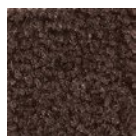

I330 maron

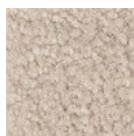

I340 beige

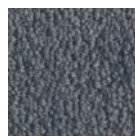

I350 blauwgrijs



I360 lichtgrijs



I370 grijs

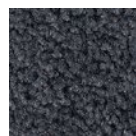

I380 donkergrijs

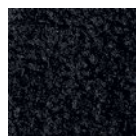

I390 zwart

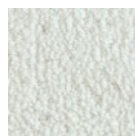

I400 wit



I410 staalgrijs

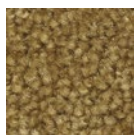

I420 goud



I430 zalm

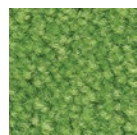

I440 felgroen



I450 sunset

type 522 P Maximus Image

ca. hoogte (mm)	22
Let op de hoogte	De exacte hoogte van de inlage kan als gevolg van een slijtlaag ca. 22 mm hoger zijn.
berijdbaarheid	Kinderwagen Steekwagen Rolstoel Winkelwagens Transportkarretjes
standaard profielafstand ca. (mm)	5 mm afstandhouder van rubber
automatische deursystemen	Profielafstand voor draaideuren optioneel in 3 mm, conform EN 16005
verbinding	met kunststof ommantelde r.v.s.-kabel.
Max. breedte uit één deel (mm)	3000
profielbreedte (mm)	27,5
Max. looplengte uit één deel (mm)	3000
gewicht (kg/m²)	10,5
Mattending conform arbo richtlijnen.	vanaf een profiellengte van 3000 mm of een maximaal matgewicht van 30 kg. Profiellengtes vanaf 2300 mm leveren wij tegen een meerprijs. De deling van de entreematten kunnen wij binnen de maximale profiellengtes en gewicht maken zoals de klant dit wenst.
draagprofielen	sterk contactgeluidgedempt aluminium draagprofiel met aan de onderzijde Premium geluiddempende stroken
Draagprofiel in kleur	Standaard aluminium. Tegen meerprijs leverbaar in de anodisatie kleuren: EV3 Gold, C33 Middelbrons, C35 Zwart of C31 RVS.
loopvlak	De emco Maximus Image inlage is geschikt voor speciale kleuren.
Anti-slip (EN 13893): Voldoet	slipvaste eigenschap R12 conform DIN 51130
brandgedrag	De entreematten zijn brandbestendig conform EN 13501 Euronorm Bfl-s1
Poolmateriaal	100% PA 6.6 (polyamide)
Classificatie	Klasse 33
Kleurecht tegen licht conform ISO 105 B02	goed 5 - 6
Kleurecht tegen wrijving conform ISO 105 X12	goed 5
Kleurecht tegen water conform ISO 105 E01	goed 5
Bacteriële reductie EHEC ASTM-e2149	29,4 %

Bacteriële reductie Staphylococcus Aureus ASTM-e2149	16,7 %
Bacteriële reductie Klebsiella Pneumoniae ASTM-e2149	68,2 %

toebehoren
emco inbouwraam 500: 500-25 AL aluminium
emco inbouwraam 500: 500-25 CN R.V.S. (V2A)
emco aanloopprofiel: A17 aluminium
emco t-profiel: T22
emco afdekprofiel: C22 R.V.S. (V2A)
emco INOX®: LINEO 22 R.V.S. (V2A)
emco INOX®: QUADRO 22 R.V.S. (V2A)
emco vuilvangbak: 5522AL aluminium
emco vuilvangbak: 5522CN R.V.S. (V2A)
emco vuilvangbak: 5522AL aluminium
emco vuilvangbak: 5522CN R.V.S. (V2A)
Rubber onderlaag 3 mm: GU 3
Rubber onderlaag 5 mm: GU 5
Rubber onderlaag 1 mm: GU 1
matverbinders: MV worden standaard meegeleverd bij matten die uit meerdere delen bestaan.

geschikt voor:
Rust- en verzorgingstehuis
Artsenpraktijk
Kantoor- en administratiegebouw
Woonhuis
Detailhandel
Hotel
Kinderdagverblijf
Wooncomplex
School
sporthal

De inlage is gecertificeerd conform TÜV PROFICERT - Product Interior (Standard)
Franse VOC wetgeving
LEED v4 (buiten Noord-Amerika)
BREEAM Exemplary level
Belgische VOC wetgeving
AgBB
MVV TB Anhang 8, 9 / ABG



type 522 P Maximus Image

service en dienstverlening

bouwhandleiding

maatvoering

Maatvoering ter plekke met behulp van laser-
maatvoeringsapparaat

plaatsingsservice

montage- en installatieservice

reparaties

Het product kan volgens milieubewust worden vernietigd of
worden gerecycleerd.

Informatie omtrent garanties vindt u op:
www.emco-bau.com/nl/garantieverklaring/

Technische wijzigingen voorbehouden

emco Benelux B.V. · Divisie Bouwtechniek · Postbus 66, NL-5320 AB Hedel ·
Baronieweg 12b, NL-5321 JW Hedel · Tel. (+31) 073 599 8310 · België / Luxem-
burg: Tel. (+32) 056 224 978 · bouwtechniek@benelux.emco.de

