

tip 522 P Maximus Image B

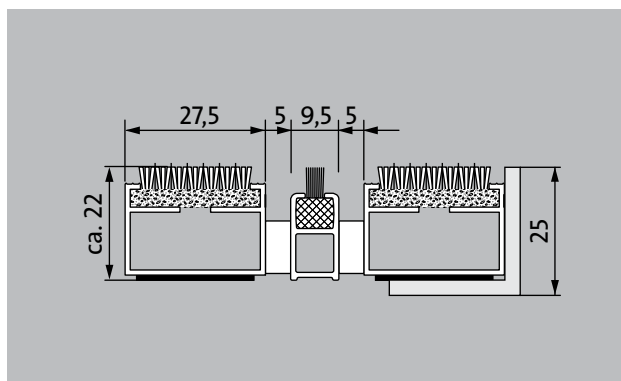
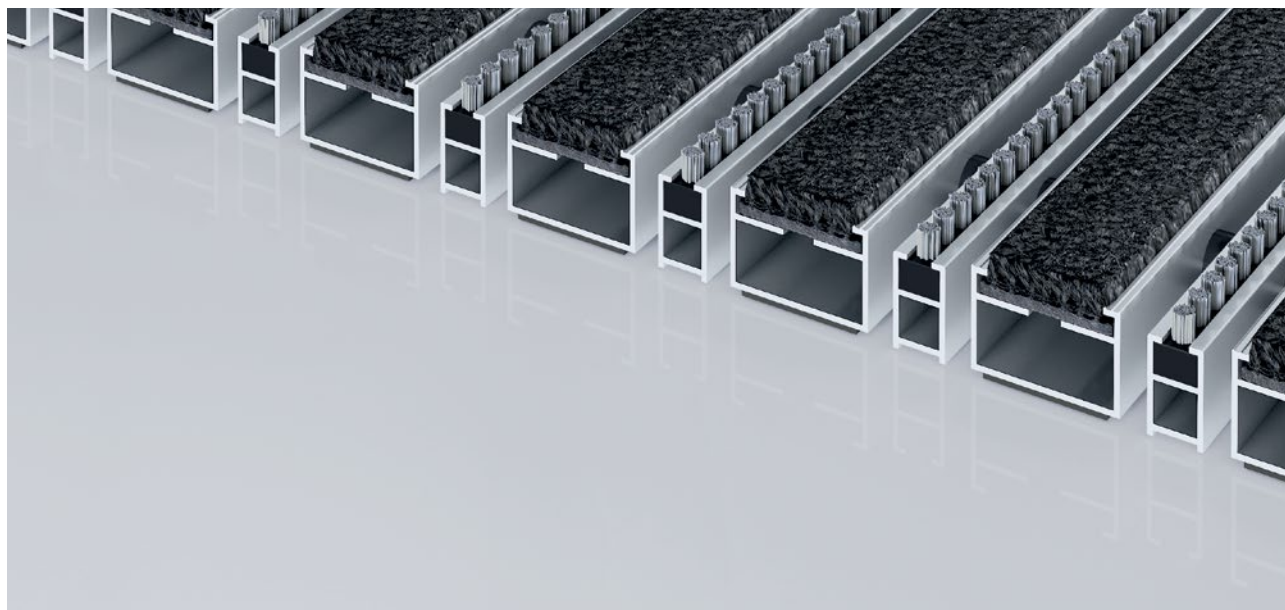

Vhodni predpražnik Premium z vložkom Maximus Image za enobarvni potisk v zeleni barvi je prva izbira, kadar gre za edinstveni dizajn in odlično zmanjšanje fine umazanije. Optimalno zasnovan za zgradbe z običajno do močno obremenitvijo.

1 **2** **3** Notranja in zunanja območja (pokrita, coni 1+2)

opis

Trpežen vhodni predpražnik Premium, ki se lahko zvije, z učinkovitim vložkom za naležno položitev. Primeren za enobarvni potisk v barvi po individualni želji. Izdelava po meri v širini in pohodni globini brez izravnalnega profila. Dobavljivo v vseh geometrijskih oblikah.



Notranja in zunanja območja (pokrita, coni 1+2)



cestni prah, lasje, pesek, pepel, tekstilna vlakna, manjši listi in vejice, itd.



moker cestni prah, peščene usedline, prah itd.



Vložek, primeren za objekt 33

tip 522 P Maximus Image B

barve



I10 limona



I20 rumena



I30 rumenooranžna



I40 oranžna



I50 Terracotta

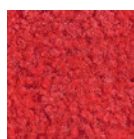

I60 rdeča

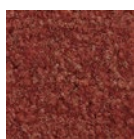

I70 Oxidnordeča

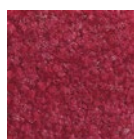

I80 Bordo



I90 svetlordeča

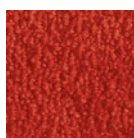

I100 češnja

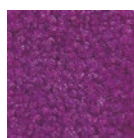

I110 vijola

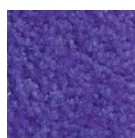

I120 Flieder



I130 Traube



I140 Magenta



I150 breskev

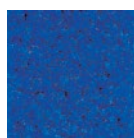

I160 kraljevsko modra

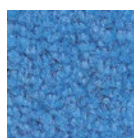

I170 svetlomodra

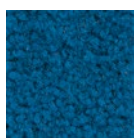

I180 Petrol

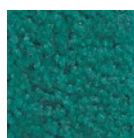

I190 Smaragdna

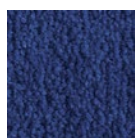

I200 Marine-modra



I210 temnozelena

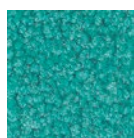

I220 Mint

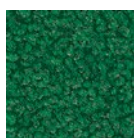

I230 listnozelena



I240 Trsnozelena

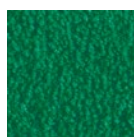

I250 zelena

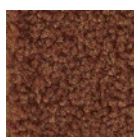

I260 rjava

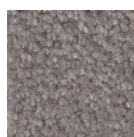

I270 grafit

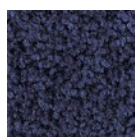

I280 jeklenomodra



I290 svetlomodra



I300 srebrna

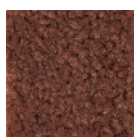

I310 srnastorjava

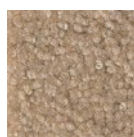

I320 peščena

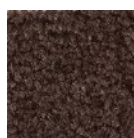

I330 kostanjeva

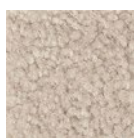

I340 sivobež

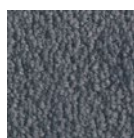

I350 modrosiva

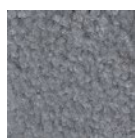

I360 svetlosiva

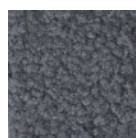

I370 siva

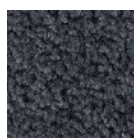

I380 temnosiva



I390 črna

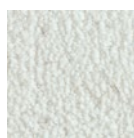

I400 bela*

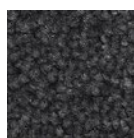

I410 jeklenosiva

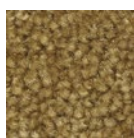

I420 zlata



I430 losos

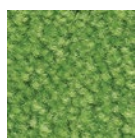

I440 svetlozelena



I450 Sunset



siva

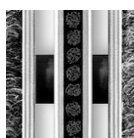

črna

tip 522 P Maximus Image B

ca. Višina (mm)	22
povoznost	otroški voziček Voziček za vreče invalidski voziček
standarden razmik med profili ca. (mm)	5, distančniki iz gume
Vrtljiva vrata	Za vrtljiva vrata so na voljo naši predpražniki s 3-mm razmikom med prečkami v skladu s standardom DIN EN 16005.
povezava	s plastiko ovito jekleno vrstico
širina profila (mm)	27,5
teža (kg/m²)	10,7
Razdelitev predpražnika po tovarniških standardih	od dolžine profila 3.000 mm ali maksimalne mase predpražnika 30 kg naprej. Dolžine profilov od 2.300 mm naprej za doplačilo. Razdelitev predpražnika je na voljo na željo stranke.
nosilni profil	iz aluminija z izolacijo proti pohodnemu zvoku na spodnji strani
Barva profila podpore	Ob doplačilu barve eloksiranja: EV3 zlata, C33 srednje bronasto eloksirano, C35 črna barva ali C31 nerjavno jeklo
nastopna ploskev	Vložek Maximus-Image je primeren za enobarvni potisk v barvi po individualni želji. Dodatni profil poveča učinek čiščenja.
gorljivost	Obnašanje vložka pri požaru v skladu z evropskim standardom EN 13501 v Bfl-s1.
Material z rebrasto zgornjo površino	100 % PA 6.6 (poliamid)
Razred obremenitve	Vložek, primeren za objekt 33

oprema

emco vgradni okvir 500: 500-25 AL aluminij
 emco vgradni okvir 500: 500-25 CN inox (V2A)
 emco naležni profil: A17 aluminij
 emco T-Profil: T22
 emco pokrovna šina: C22 inox (V2A)
 emco INOX®: LINEO 22 inox (V2A)
 emco INOX®: QUADRO 22 inox (V2A)
 emco zbiralna posoda za umazanijo: 5522AL aluminij
 emco zbiralna posoda za umazanijo: 5522CN inox (V2A)

Gumijasta podloga 1 mm: GU1

Garancijski pogoji so na voljo na spletni povezavi:

www.emco-bau.com/sl/garancijski-pogoji-vhodnih-predpraznikov-emco/

Gumijasta podloga 3 mm: GU3

Pridržujemo si pravico do tehničnih sprememb / zaradi proizvodnega procesa lahko pride do barvnih odstopanj

Gumijasta podloga 5 mm: GU 5

emco, proizvajalec in distributer, Praterstraße 349, D-49808 Lingen, Nemčija

Tel.: +49 (0) 591/9140-500 Fax: +49 (0) 591/9140-852

e-naslov: bau@emco.de · www.emco-bau.com

Primerno za:

Dom upokojencev in negovalni dom
 Zdravniška ordinacija
 pisarniški in upravni prostori
 Enodružinska hiša
 Trgovina na drobno
 Hotel
 Vrtec
 Večdružinska hiša
 Šola
 Športna dvorana

Vložek je certificiran v skladu s postopkom TÜV PROFICERT - product Interior (Standard)

Francoška uredba VOC (Uredba o hlapnih organskih snoveh)
 LEED v4 (izven Severne Amerike)
 Eksemplarična stopnja BREEM
 Belgijska uredba VOC (Uredba o hlapnih organskih snoveh)
 AgBB (Odbor za zdravstveno vrednotenje gradbenih proizvodov)
 MVV TB Priloga 8, 9 / Splošni pogoji

servis in usluge.

svetovanje za gradbišča
 izmera
 izmera z laserkim aparatom na licu mesta
 polagalski servis
 polagalski in vpasovalni servis
 popravila
 Izdelek se lahko odstrani primerno okolju ali reciklira.