

# Model 522 PS Maximus Image

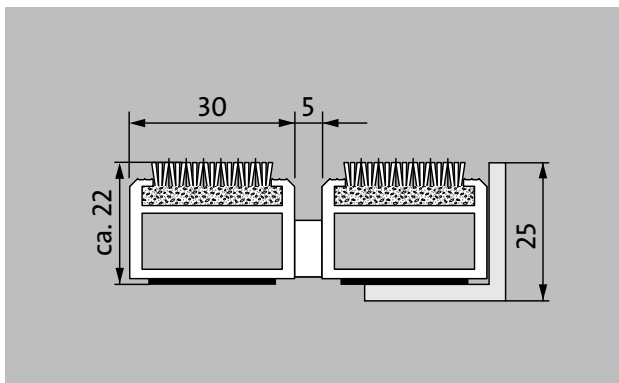
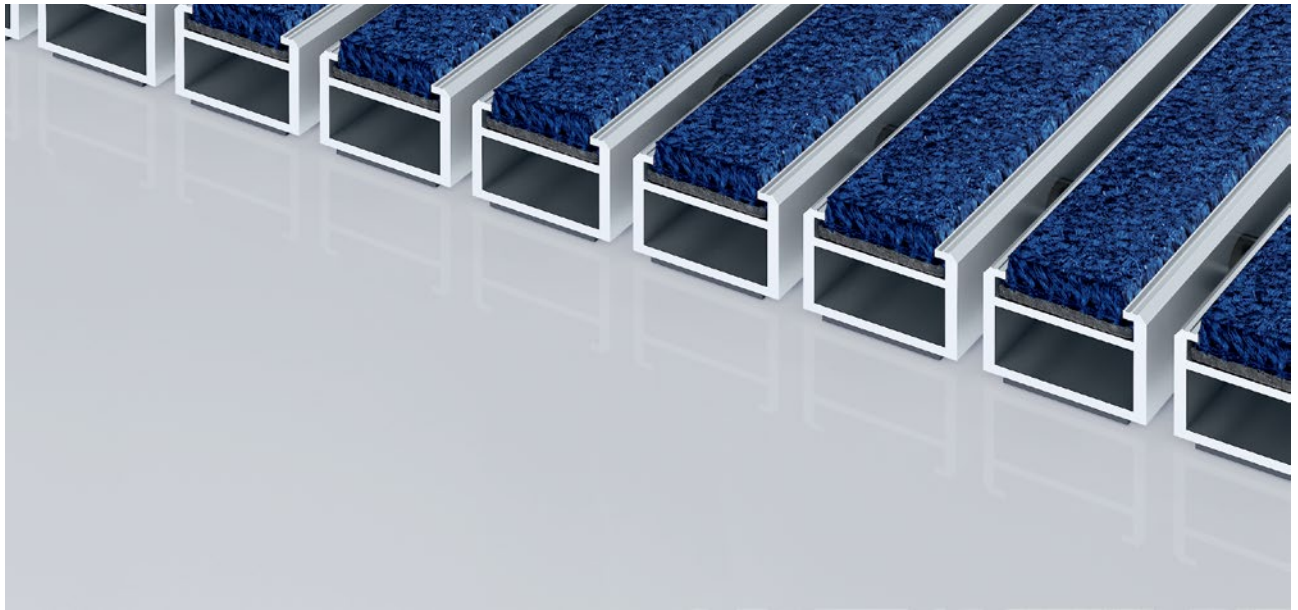

The Premium entrance mat with the Maximus Image insert for the single-colour printing of personally chosen colours is the first choice when it comes to unique design and excellent reduction of fine dirt. Ideal for buildings with extreme loads. For laying on top of existing flooring.

- 1
- 2
- 3 Indoor and outdoor (covered, Zone 1+2)

### Description

Rollable, extremely hard-wearing, premium entrance mat with performance insert for supported and self-supporting installation options. Also capable of withstanding wheeled traffic. Suitable for single-colour printing of individual colour preferences. Customisable widths and walking depths available without a compensation profile. Available in any geometric shape.



Indoor and outdoor (covered, Zone 1+2)



Street dust, hair, sand, ash, textile fibres, small leaves and twigs, etc.



Damp street dust, damp sand deposits, dust, etc.



R 12 slip resistance as per DIN 51130



5 years guarantee

























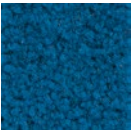

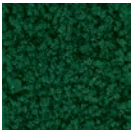
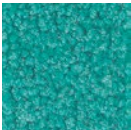
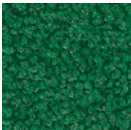
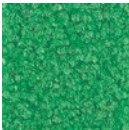

Bfl-s1



class 33 (heavy commercial use)

# Model 522 PS Maximus Image

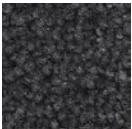
Colours

							
I10 Lemon	I20 Yellow	I30 Yellow/ orange	I40 Orange	I50 Terracotta	I60 Red	I70 Oxide red	I80 Bordeaux
							
I90 Light red	I100 Cherry	I110 Purple	I120 Lilac	I130 Grape	I140 Magenta	I150 Peach	I160 Royal blue
							
I170 Light blue	I180 Petrol blue	I190 Emerald green	I200 Marine blue	I210 Dark green	I220 Mint	I230 Leaf green	I240 Reed green
							
I250 Green	I260 Brown	I270 Graphite	I280 Steel blue	I290 Light blue	I300 Silver	I310 Fawn brown	I320 Sand
							
I330 Chestnut	I340 Grey beige	I350 Blue grey	I360 Light grey	I370 Grey	I380 Dark grey	I390 Black	I400 White*
							
I410 Steel grey	I420 Gold	I430 Salmon pink	I440 Light green	I450 Sunset			

## Model 522 PS Maximus Image

<b>Approx. height (mm)</b>	22
<b>Note on height</b>	The insert can actually be approx. 2-3 mm higher due to the wear layer.
<b>Roll-over and drive-over capability:</b>	<p>Prams</p> <p>Sack-/hand truck</p> <p>Wheelchairs</p> <p>Light shopping trolleys</p> <p>hand trolleys</p> <p>pallet trucks</p> <p>Electric lift truck</p> <p>Cars</p> <p>Lifting platform (i.e scissor lift )</p>
<b>Standard profile clearance approx. (mm)</b>	5 mm, rubber spacers
<b>Automatic door systems</b>	Profile clearance of 3 mm available as an option for revolving door drives, in accordance with EN 16005
<b>Connection</b>	Plastic-coated steel cable
<b>Max. width/profile length for individual section (mm):</b>	3000
<b>Profile width (mm)</b>	30
<b>Depth/walking depth for individual section (mm):</b>	3000
<b>Weight (kg/m<sup>2</sup>)</b>	16,8
<b>Mat division as per factory standards</b>	From a profile length of 3000 mm or a maximum mat weight of 30 kg. For profile lengths above 2300 mm, a surcharge is applicable . Mat deviations/splits possible at customer's request.
<b>Support chassis</b>	Reinforced support chassis made using rigid aluminium with Premium sound absorbing insulation on the underside
<b>Support chassis colour</b>	Aluminium as standard. Anodised colours for an additional charge: EV3 gold, C33 mid-bronze, C35 black or C31 stainless steel
<b>Tread surface</b>	Embedded, robust MAXIMUS inserts in Bfl-S1 quality (clean-off floor covering made from special polyamide yarn, 100%)
<b>Slip resistance</b>	R 12 slip resistance as per DIN 51130
<b>Flammability</b>	Fire classification for the complete mat system Bfl-s1 in accordance with EN 13501
<b>Pile material</b>	100% PA 6.6 (polyamide)
<b>Use classification EN1307</b>	class 33 (heavy commercial use)
<b>Colour fastness to artificial light ISO 105-B02</b>	good 5-6

<b>Colour fastness to rubbing ISO 105 X12</b>	good 5
<b>Colour fastness to water ISO 105 E01</b>	good 5
<b>Bacterial reduction EHEC ASTM-e2149</b>	29,4 %
<b>Bacterial reduction staphylococcus aureus ASTM-e2149</b>	16,7 %
<b>Bacterial reduction klebsiella pneumoniae ASTM-e2149</b>	68,2 %

## Model 522 PS Maximus Image

Accessories
emco installation frame 500: 500-25 AL Aluminium
emco installation frame 500: 500-25 CN Chrome-nickel steel (V2A)
emco LUMINA: LUMINA Aluminium
emco LUMINA: LUMINA + LED Aluminium
emco LUMINA: LUMINA VIA Aluminium
emco ramp edge: A17 Aluminium
emco T-profile: T22
emco cover strip: C22 Chrome-nickel steel (V2A)
emco INOX®: LINEO 22 Chrome-nickel steel (V2A)
emco INOX®: QUADRO 22 Chrome-nickel steel (V2A)
emco dirt collection well: 5000 AL Aluminium
emco dirt collection well: 5000 CN Chrome-nickel steel (V2A)
emco dirt collection well: 5000 AL+ Aluminium
emco dirt collection well: 5000 CN+ Chrome-nickel steel (V2A)
emco dirt collection well: 5022 AL Aluminium
emco dirt collection well: 5022 CN Chrome-nickel steel (V2A)
emco dirt collection well: 5022 AL+ Aluminium
emco dirt collection well: 5022 CN+ Chrome-nickel steel (V2A)
emco dirt collection well: 5522AL Aluminium
emco dirt collection well: 5522CN Chrome-nickel steel (V2A)
emco dirt collection well: 5022 AL Aluminium
emco dirt collection well: 5022 CN Chrome-nickel steel (V2A)
emco dirt collection well: 5522AL Aluminium
emco dirt collection well: 5522CN Chrome-nickel steel (V2A)
emco dirt collection well: 5022 AL+ Aluminium
emco dirt collection well: 5022 CN+ Chrome-nickel steel (V2A)
emco dirt collection well: 5000 AL Aluminium
emco dirt collection well: 5000 CN Chrome-nickel steel (V2A)
emco dirt collection well: 5000 AL+ Aluminium
emco dirt collection well: 5000 CN+ Chrome-nickel steel (V2A)
emco special frame with substructure: A Version A: with installation frame, rectangular tube profiles, grid support and height adjustment.
emco special frame with substructure: B Version B: with installation frame, grid support and rectangular tube profiles
emco special frame with substructure: C Type C: with installation frame and rectangular tube profiles
Rubber underlay 3 mm: GU 3
Rubber underlay 5 mm: GU 5
Rubber underlay 1 mm: GU 1

Warranty conditions are available at:  
[www.emco-bau.com/en/warranty-conditions/](http://www.emco-bau.com/en/warranty-conditions/)

Subject to technical modifications.  
 Mat joining brackets: MV Supplied as standard with mats in several parts

emco Bautechnik GmbH · Breslauer Straße 34 - 38 · D-49808 Lingen (Ems)  
 · Germany · Phone: +49 (0) 591/9140-500 · Fax: +49 (0) 591/9140-852 · Email:  
 bau@emco.de · www.emco-bau.com

Suitable for:
Retirement homes and Care-/Nursery Homes
Arena
medical practice
Train station
DIY store
Offices and administrative buildings
Family home
Shopping centre
Retail sector
University / Higher education institution
airport
Hotel
Industry
Kindergarten/Nursery
Clinic/Hospital
Warehouse
Apartment building
Trade fair
School
Sports hall
Supermarket

Insert certified to TÜV PROFiCERT- product interior (Standard)
French VOC regulation
LEED v4 (outside North America)
BREEAM Exemplary Level
Belgian VOC regulation
AgBB (Committee for Health-related Evaluation of Building Products)
MVV TB Appendix 8, 9 / ABG

Service and services
Construction site advice
Dimensioning
Measured using laser measuring device on site.
Installation service
Fitting and installation service
Repairs
The product can be disposed of or recycled in an environmentally friendly way.

