

tip 522 PL Maximus Image + Design

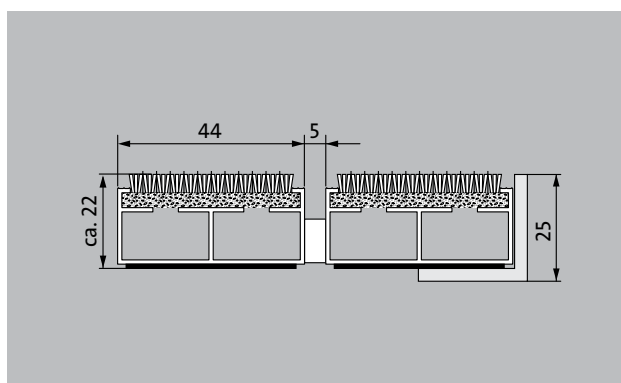

Posebno širok vhodni predpražnik Premium z vložkom Maximus Image Logo za potisk z logotipom in napisom je prva izbira, kadar gre za osebni dizajn in odlično zmanjšanje fine umazanije. Optimalno zasnovan za zgradbe z običajno do močno obremenitvijo.

1 **2** **3** Notranja in zunanja območja (pokrita, cona 1+2)

opis

Trpežen vhodni predpražnik Premium, ki se lahko zvije, s posebno širokimi profilnimi palicami in učinkovitim vložkom za naležno položitev. Primeren za večbarvni potisk z oblikami, logotipi in napisi. Izdelava po meri v širini in pohodni globini brez izravnalnega profila. Dobavljivo v vseh geometrijskih oblikah.

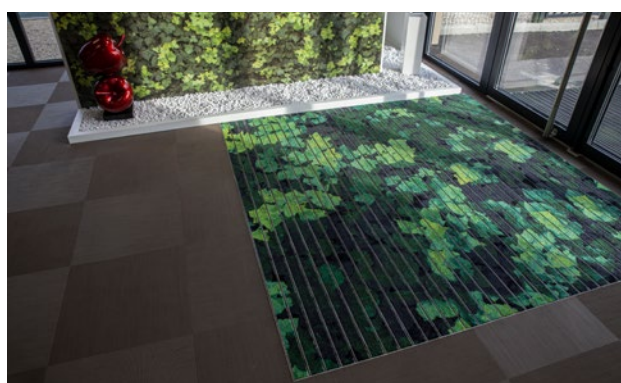

Notranja in zunanja območja (pokrita, cona 1+2)



cestni prah, lasje, pesek, pepel, tekstilna vlakna, manjši listi in vejice, itd.



moker cestni prah, peščene usedline, prah itd.



protizdrsna lastnost R 12 po DIN 51130



5 Year Guarantee



Bfl-s1



Primerno za objekt 33

tip 522 PL Maximus Image + Design

barve



I10 limona



I20 rumena



I30 rumenooranžna



I40 oranžna



I50 Terracotta



I60 rdeča

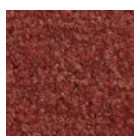

I70 Oxidnordeča

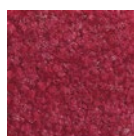

I80 Bordo



I90 svetlordeča

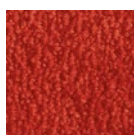

I100 češnja

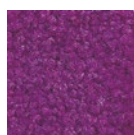

I110 vijola

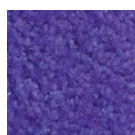

I120 Flieder



I130 Traube



I140 Magenta



I150 breskev

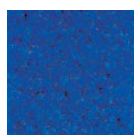

I160 kraljevsko modra

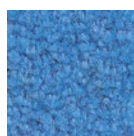

I170 svetlomodra

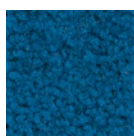

I180 Petrol

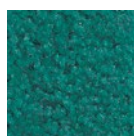

I190 Smaragdna

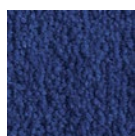

I200 Marine-modra



I210 temnozelena



I220 Mint

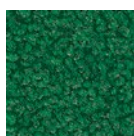

I230 listnozelena



I240 Trsnozelena

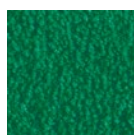

I250 zelena

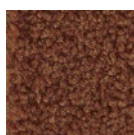

I260 rjava

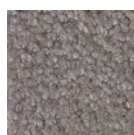

I270 grafit



I280 jeklenomodra

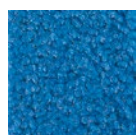

I290 svetlomodra



I300 srebrna



I310 srnastorjava



I320 peščena

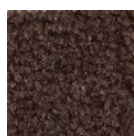

I330 kostanjeva

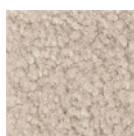

I340 sivobež

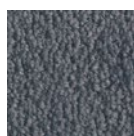

I350 modrosiva

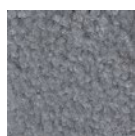

I360 svetlosiva



I370 siva

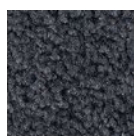

I380 temnosiva

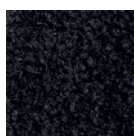

I390 črna

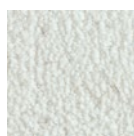

I400 bela*

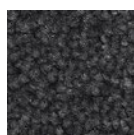

I410 jeklenosiva

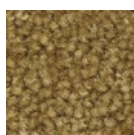

I420 zlata



I430 losos

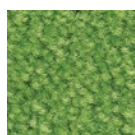

I440 svetlozelena



I450 Sunset

tip 522 PL Maximus Image + Design

ca. Višina (mm)	22
Opozorilo glede višine	Dejanska višina vložka je lahko zaradi uporabnega sloja za ca. 2 mm višja.
povožnost	otroški voziček Voziček za vreče invalidski voziček nakupovalni voziček transportni vozički
standarden razmik med profili ca. (mm)	5, distančniki iz gume
avtomatski sistemi vrat	presledek med profili opcijsko tudi 3 mm za predel rotirajočih vrat po EN 16005
povezava	s plastiko ovito jekleno vrvico
maks. širina/dolžina profilov, enodelna (mm):	3000
širina profila (mm)	44
Globina/Pohodna globina, enodelen (mm):	1500
teža (kg/m²)	10,4
Razdelitev predpražnika po tovarniških standardih	od dolžine profila 3.000 mm ali maksimalne mase predpražnika 30 kg naprej. Dolžine profilov od 2.300 mm naprej za doplačilo. Razdelitev predpražnika je na voljo na željo stranke.
nosilni profil	iz torzijsko trdnega aluminija, z izolacijo Premium proti pohodnemu zvoku na spodnji strani
Barva profila podpore	Standardni aluminij. Za doplačilo anodizirane barve: EV3 zlate barve, C33 srednje bronasto eloksirano, C35 črne barve ali C31 nerjavno jeklo
nastopna ploskev	Vložek Maximus-Image-Logo je primeren za enobarvni potisk logotipov in napisov.
Protizdrsna varnost	protizdrsna lastnost R 12 po DIN 51130
gorljivost	gorljivost kompletnega predpražnika po EN 13501 in Bfl-s1
Material z rebrasto zgornjo površino	100 % PA 6.6 (poliamid)
Razred obremenitve	Primerno za objekt 33
Barvna obstojnost proti svetlobi ISO 105 B02	dobro 5-6
Barvna obstojnost proti drgnjenju ISO 105 X12	dobro 5
Barvna obstojnost proti vodi ISO 105 E01	dobro 5
Zmanjšanje bakterij EHEC ASTM-e2149	29,4 %

Zmanjšanje bakterij vrste Staphylococcus Aureus ASTM-e2149	16,7 %
Zmanjšanje bakterij vrste Klebsiella, ki povzročajo pljučnico, ASTM-e2149	68,2 %

oprema
emco vgradni okvir 500: 500-25 AL aluminij
emco vgradni okvir 500: 500-25 CN inox (V2A)
emco naležni profil: A17 aluminij
emco T-Profil: T22
emco pokrovna šina: C22 inox (V2A)
emco INOX®: LINEO 22 inox (V2A)
emco INOX®: QUADRO 22 inox (V2A)
emco zbiralna posoda za umazanijo: 5522AL aluminij
emco zbiralna posoda za umazanijo: 5522CN inox (V2A)
emco zbiralna posoda za umazanijo: 5522AL aluminij
emco zbiralna posoda za umazanijo: 5522CN inox (V2A)
Gumijasta podloga 3 mm: GU 3
Gumijasta podloga 5 mm: GU 5
Gumijasta podloga 1 mm: GU 1
povezovalni elementi predpražnika: MV pri večdelnih predpražnikih standardno priloženi pošiljki

Primerne za:
Dom upokojevcev in negovalni dom
Zdravniška ordinacija
pisarniški in upravni prostori
Enodružinska hiša
Trgovina na drobno
Hotel
Vrtec
Večdružinska hiša
Šola
Športna dvorana

Vložek je certificiran v skladu s postopkom TÜV PROFiCERT - product Interior (Standard)
Francoška uredba VOC (Uredba o hlapnih organskih snoveh)
LEED v4 (izven Severne Amerike)
Eksemplarična stopnja BREEM
Belgijska uredba VOC (Uredba o hlapnih organskih snoveh)
AgBB (Odbor za zdravstveno vrednotenje gradbenih proizvodov)
MVV TB Priloga 8, 9 / Splošni pogoji



emco DIPLOMAT Premium Large (velik) z vložkom Maximus Image

tip 522 PL Maximus Image + Design

servis in usluge.

svetovanje za gradbišča

izmera

izmera z laserkim aparatom na licu mesta

polagalski servis

polagalski in vpasovalni servis

popravila

Izdelek se lahko odstrani primerno okolju ali reciklira.

Garancijski pogoji so na voljo na spletni povezavi:
www.emco-bau.com/sl/garancijski-pogoj-vhodnih-predpraznikov-emco/

Pridržujemo si pravico do tehničnih sprememb

MEDI-A-NORM D.O.O. · CESTA V MESTNI LOG 28 · 1000 LJUBLJANA · Slovenija
· Tel. (+386) 51 435 159 · info@emco.si · www.emco-bau.com

