

# Model 522 PL Conform

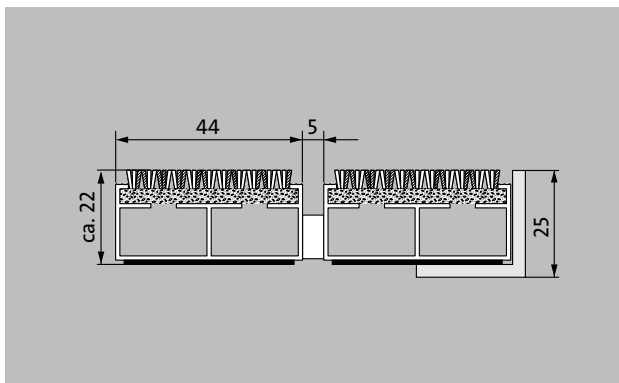

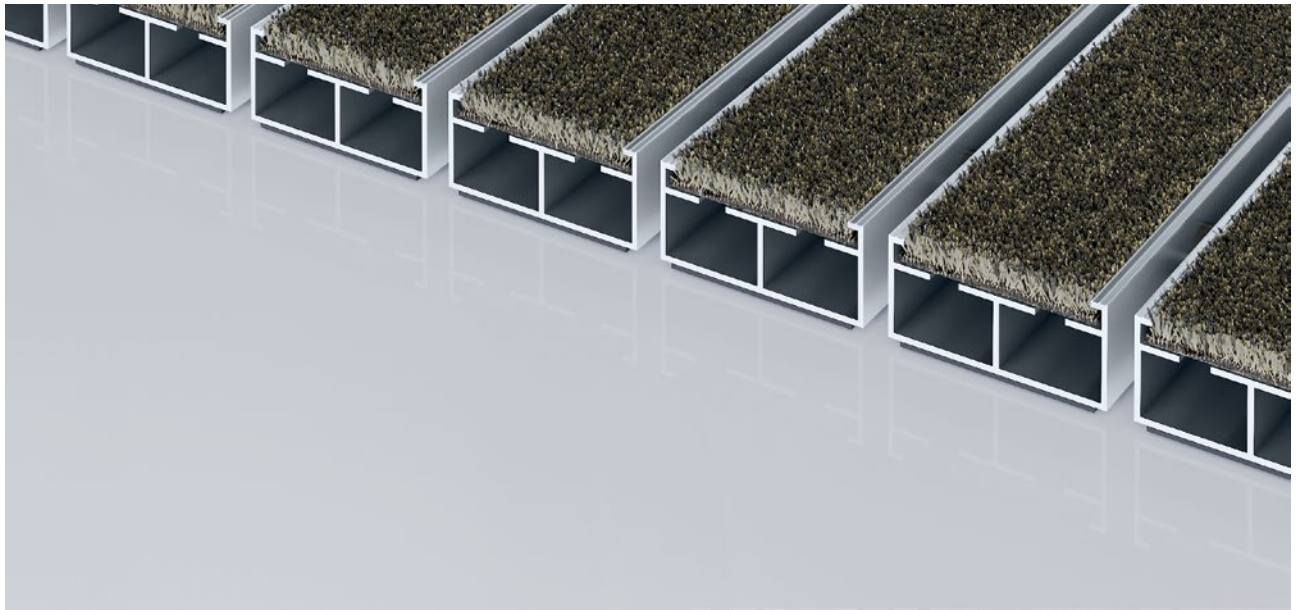





The extra-wide premium entrance mat with the Conform insert made of recycled materials is the perfect complement to wooden surroundings and can be used in a whole host of environments. Particularly ideal for collecting fine dirt. Optimally designed for buildings exposed to average to heavy footfall.

- 1**
- 2**
- 3** Indoor and outdoor (covered, Zone 1+2)

### Description

Rollable and hard-wearing premium entrance mat with extra-wide profile bars and performance insert for supported installation options. Customisable widths and walking depths available without a compensation profile. Available in any geometric shape.



-   
 Indoor and outdoor (covered, Zone 1+2)
-   
 Street dust, hair, sand, ash, textile fibres, small leaves and twigs, etc.
-   
 Damp street dust, damp sand deposits, dust, etc.
-   
 R 12 slip resistance as per DIN 51130
-   
 5 years guarantee
-   
 Cfl-s1
-   
 class 32 (general commercial use)

## Model 522 PL Conform

<b>Approx. height (mm)</b>	22
<b>Note on height</b>	The insert can actually be approx. 2 mm higher due to the wear layer.
<b>Roll-over and drive-over capability:</b>	<p>Prams</p> <p>Sack-/hand truck</p> <p>Wheelchairs</p> <p>Light shopping trolleys</p> <p>hand trolleys</p>
<b>Standard profile clearance approx. (mm)</b>	5 mm, rubber spacers
<b>Automatic door systems</b>	Profile clearance of 3 mm available as an option for revolving door drives, in accordance with EN 16005
<b>Connection</b>	Plastic-coated stainless steel cable
<b>Max. width/profile length for individual section (mm):</b>	3000
<b>Profile width (mm)</b>	44
<b>Depth/walking depth for individual section (mm):</b>	1500
<b>Weight (kg/m<sup>2</sup>)</b>	10,6
<b>Mat division as per factory standards</b>	From a profile length of 3000 mm or a maximum mat weight of 30 kg. For profile lengths above 2300 mm, a surcharge is applicable. Mat deviations/splits possible at customer's request.
<b>Support chassis</b>	Made using rigid aluminium with Premium sound absorbing insulation on the underside
<b>Support chassis colour</b>	Aluminium as standard. Anodised colours for an additional charge: EV3 gold, C33 mid-bronze, C35 black or C31 stainless steel
<b>Tread surface</b>	The Conform insert made of recycled materials is the perfect complement to wooden surroundings and can be used in a whole host of environments.
<b>Slip resistance</b>	R 12 slip resistance as per DIN 51130
<b>Flammability</b>	Fire classification for the complete mat system Cf1-s1 in accordance with EN 13501
<b>Pile material</b>	100% PA 6 (polyamide)
<b>Use classification EN1307</b>	class 33 (heavy commercial use)
<b>Bacterial reduction EHEC ASTM-e2149</b>	16,1 %
<b>Bacterial reduction staphylococcus aureus ASTM-e2149</b>	0,0 %

<b>Bacterial reduction klebsiella pneumoniae ASTM-e2149</b>	65,6 %
---	--------

<b>Accessories</b>	
emco installation frame 500: 500-25 AL Aluminium	
emco installation frame 500: 500-25 CN Chrome-nickel steel (V2A)	
emco LUMINA: LUMINA Aluminium	
emco LUMINA: LUMINA + LED Aluminium	
emco LUMINA: LUMINA VIA Aluminium	
emco ramp edge: A17 Aluminium	
emco T-profile: T22	
emco cover strip: C22 Chrome-nickel steel (V2A)	
emco INOX®: LINEO 22 Chrome-nickel steel (V2A)	
emco INOX®: QUADRO 22 Chrome-nickel steel (V2A)	
emco dirt collection well: 5522AL Aluminium	
emco dirt collection well: 5522CN Chrome-nickel steel (V2A)	
emco dirt collection well: 5522AL Aluminium	
emco dirt collection well: 5522CN Chrome-nickel steel (V2A)	
Rubber underlay 3 mm: GU 3	
Rubber underlay 5 mm: GU 5	
Rubber underlay 1 mm: GU 1	
Mat joining brackets: MV Supplied as standard with mats in several parts	

<b>Suitable for:</b>
Retirement homes and Care-/Nursery Homes
medical practice
Offices and administrative buildings
Family home
Retail sector
Hotel
Kindergarten/Nursery
Apartment building
School
Sports hall

# emco DIPLOMAT Premium Large With Conform insert

---

## Model 522 PL Conform

### Insert certified to TÜV PROFiCERT- product interior (Standard)

French VOC regulation

LEED v4 (outside North America)

BREEAM Exemplary Level

Belgian VOC regulation

AgBB (Committee for Health-related Evaluation of Building Products)

MVV TB Appendix 8, 9 / ABG

### Service and services

Construction site advice

Dimensioning

Measured using laser measuring device on site.

Installation service

Fitting and installation service

Repairs

The product can be disposed of or recycled in an environmentally friendly way.

## Model 522 PL Conform

### Colours

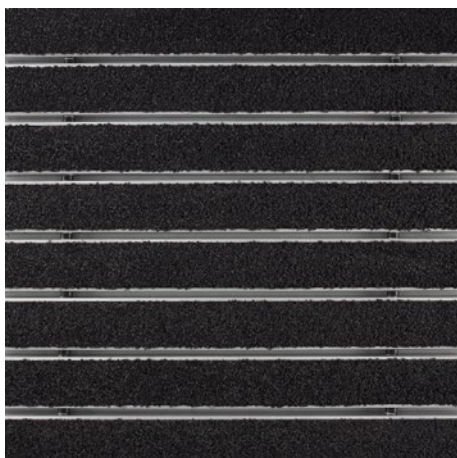

Anthracite 76.01



Beige 76.02

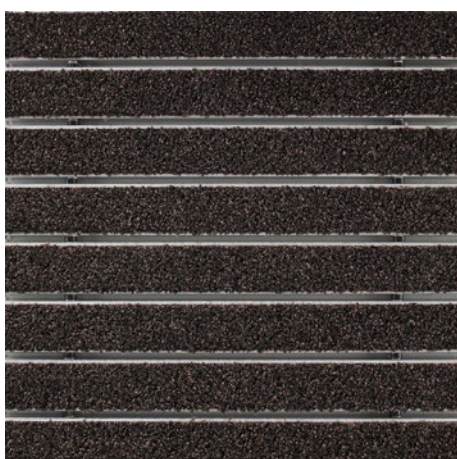

Brown 76.04

Warranty conditions are available at:  
[www.emco-bau.com/en/warranty-conditions/](http://www.emco-bau.com/en/warranty-conditions/)

Subject to technical modifications

emco Bautechnik GmbH · Breslauer Straße 34 - 38 · D-49808 Lingen (Ems)  
· Germany · Phone: +49 (0) 591/9140-500 · Fax: +49 (0) 591/9140-852 · Email:  
[bau@emco.de](mailto:bau@emco.de) · [www.emco-bau.com](http://www.emco-bau.com)