

emco DIPLOMAT Premium z vložkom Maximus Image in strgalnim ro- bom

tip 517 P Maximus Image K

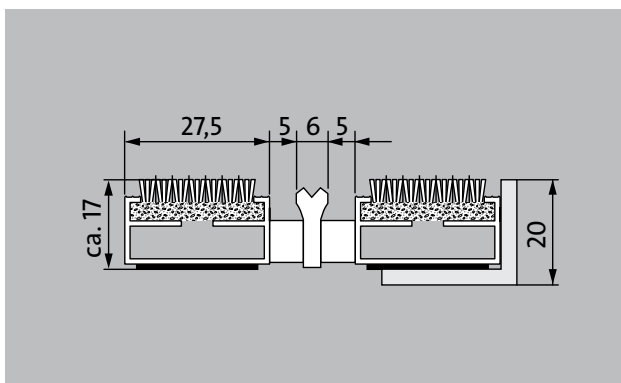
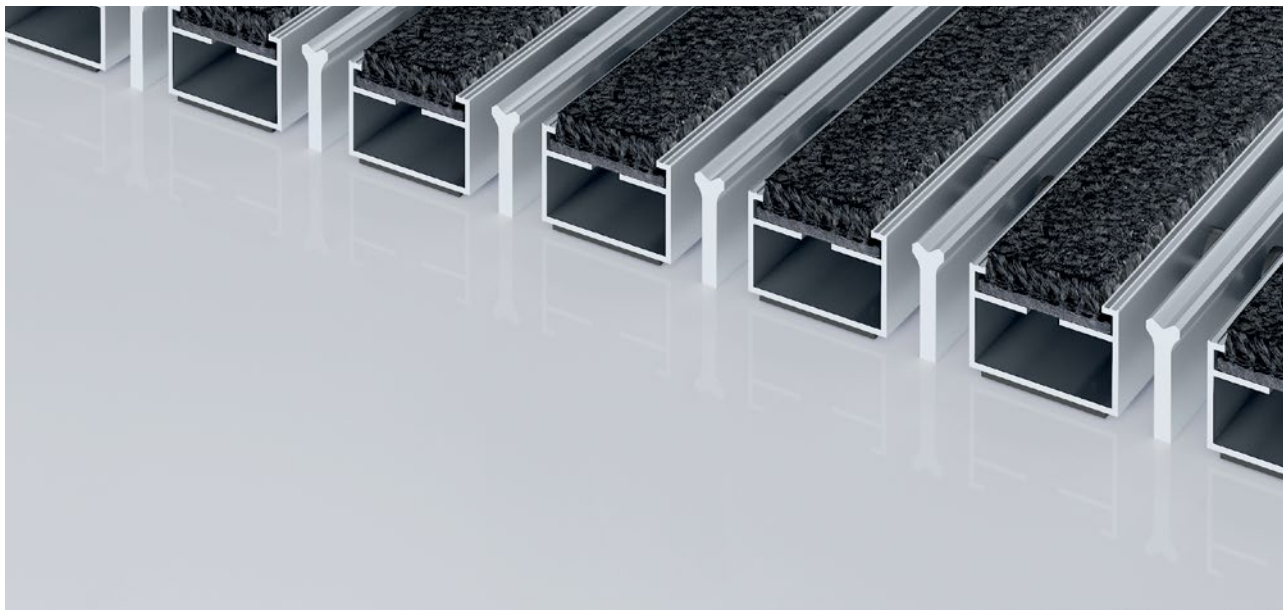

Vhodni predpražnik Premium z vložkom Maximus Image za enobarvni potisk v zeleni barvi je prva izbira, kadar gre za edinstveni dizajn in odlično zmanjšanje fine umazanije. Optimalno zasnovan za zgradbe z običajno do močno obremenitvijo.

1 **2** **3** Notranja in zunanja območja (pokrita, coni 1+2)

opis

Trpežen vhodni predpražnik Premium, ki se lahko zvije, z učinkovitim vložkom za naležno položitev. Primeren za enobarvni potisk v barvi po individualni želji. Izdelava po meri v širini in pohodni globini brez izravnalnega profila. Dobavljivo v vseh geometrijskih oblikah.



Notranja in zunanja območja (pokrita, coni 1+2)



cestni prah, lasje, pesek, pepel, tekstilna vlakna, manjši listi in vejice, itd.



moker cestni prah, peščene usedline, prah itd.



Primerno za objekt 33

emco DIPLOMAT Premium z vložkom Maximus Image in strgalnim robom

tip 517 P Maximus Image K

barve



I10 limona



I20 rumena



I30 rumenooranžna



I40 oranžna



I50 Terracotta

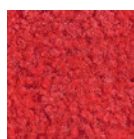

I60 rdeča

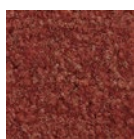

I70 Oxidnordeča

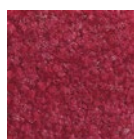

I80 Bordo



I90 svetlordeča

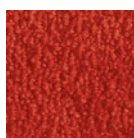

I100 češnja

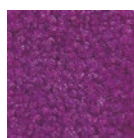

I110 vijola

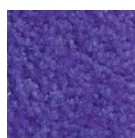

I120 Flieder



I130 Traube



I140 Magenta



I150 breskev

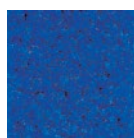

I160 kraljevsko modra



I170 svetlomodra

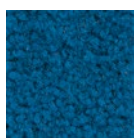

I180 Petrol

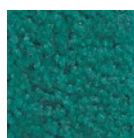

I190 Smaragdna

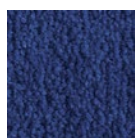

I200 Marine-modra



I210 temnozelena

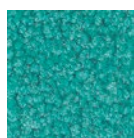

I220 Mint

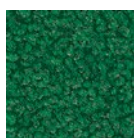

I230 listnozelena



I240 Trsnozelena

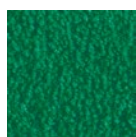

I250 zelena

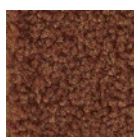

I260 rjava

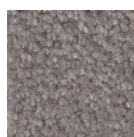

I270 grafit

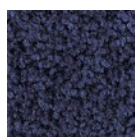

I280 jeklenomodra



I290 svetlomodra



I300 srebrna

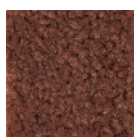

I310 srnastorjava

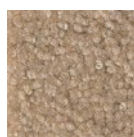

I320 peščena

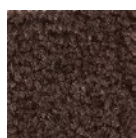

I330 kostanjeva

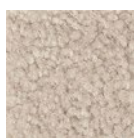

I340 sivobež

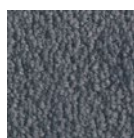

I350 modrosiva

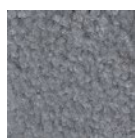

I360 svetlosiva

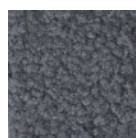

I370 siva

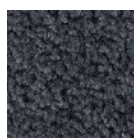

I380 temnosiva



I390 črna

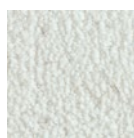

I400 bela*



I410 jeklenosiva

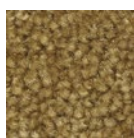

I420 zlata



I430 losos

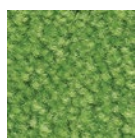

I440 svetlozelena



I450 Sunset

emco DIPLOMAT Premium z vložkom Maximus Image in strgalnim robom

tip 517 P Maximus Image K

ca. Višina (mm)	17
povožnost	otroški voziček Voziček za vreče invalidski voziček
standarden razmik med profili ca. (mm)	5, distančniki iz gume
avtomatski sistemi vrat	presledek med profili opcijsko tudi 3 mm za predel rotirajočih vrat po EN 16005
povezava	s plastiko ovito jekleno vrvico
maks. širina/dolžina profilov, enodelna (mm):	3000
širina profila (mm)	27.5
Globina/Pohodna globina, enodelna (mm):	3000
teža (kg/m²)	10,3
Razdelitev predpražnika po tovarniških standardih	od dolžine profila 3.000 mm ali maksimalne mase predpražnika 30 kg naprej. Dolžine profilov od 2.300 mm naprej za doplačilo. Razdelitev predpražnika je na voljo na željo stranke.
nosilni profil	iz torzijsko trdnega aluminija, z izolacijo Premium proti pohodnemu zvoku na spodnji strani
Barva profila podpore	Standardni aluminij. Za doplačilo anodizirane barve: EV3 zlate barve, C33 srednje bronasto eloksirano, C35 črne barve ali C31 nerjavno jeklo
nastopna ploskev	Vložek Maximus-Image je primeren za enobarvni potisk v barvi po individualni želji. Dodatni profil poveča učinek čiščenja.
gorljivost	Obnašanje vložka pri požaru v skladu z evropskim standardom EN 13501 v Bfl-s1.
Material z rebrasto zgornjo površino	100 % PA 6.6 (poliamid)
Razred obremenitve	Primereno za objekt 33

oprema
emco vgradni okvir 500: 500-20 AL aluminij
emco vgradni okvir 500: 500-20 CN inox (V2A)
emco naležni profil: A17 aluminij
emco T-Profil: T17
emco pokrovna šina: C17 inox (V2A)
emco INOX®: LINEO 17 inox (V2A)
emco INOX®: QUADRO 17 inox (V2A)
emco zbiralna posoda za umazanijo: 5517AL aluminij
emco zbiralna posoda za umazanijo: 5517CN inox (V2A)
emco zbiralna posoda za umazanijo: 5517AL aluminij
emco zbiralna posoda za umazanijo: 5517CN inox (V2A)
Gumijasta podloga 3 mm: GU 3
Gumijasta podloga 5 mm: GU 5
Gumijasta podloga 1 mm: GU 1
povezovalni elementi predpražnika: MV pri večdelnih predpražnikih standardno priloženi pošiljki

Primereno za:
Dom upokojencev in negovalni dom
Zdravniška ordinacija
pisarniški in upravni prostori
Enodružinska hiša
Trgovina na drobno
Hotel
Vrtec
Večdružinska hiša
Šola
Športna dvorana

Vložek je certificiran v skladu s postopkom TÜV PROFICERT - product Interior (Standard)
Francoska uredba VOC (Uredba o hlapnih organskih snoveh)
LEED v4 (izven Severne Amerike)
Eksemplarična stopnja BREAM
Belgijska uredba VOC (Uredba o hlapnih organskih snoveh)
AgBB (Odbor za zdravstveno vrednotenje gradbenih proizvodov)
MVV TB Priloga 8, 9 / Splošni pogoji

emco DIPLOMAT Premium z vložkom Maximus Image in strgalnim ro- bom

tip 517 P Maximus Image K

servis in usluge.

svetovanje za gradbišča

izmera

izmera z laserkim aparatom na licu mesta

polagalski servis

polagalski in vpasovalni servis

popravila

Izdelek se lahko odstrani primerno okolju ali reciklira.

Garancijski pogoji so na voljo na spletni povezavi:
www.emco-bau.com/sl/garancijski-pogoj-vhodnih-predpraznikov-emco/

Pridržujemo si pravico do tehničnih sprememb

MEDI-A-NORM D.O.O. · CESTA V MESTNI LOG 28 · 1000 LJUBLJANA · Slovenija
· Tel. (+386) 51 435 159 · info@emco.si · www.emco-bau.com

