

Model 517 P Maximus Image K

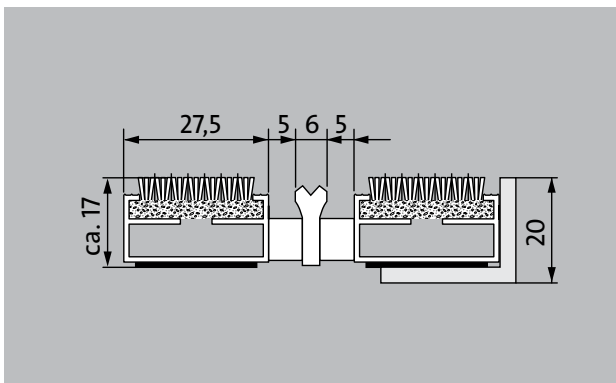
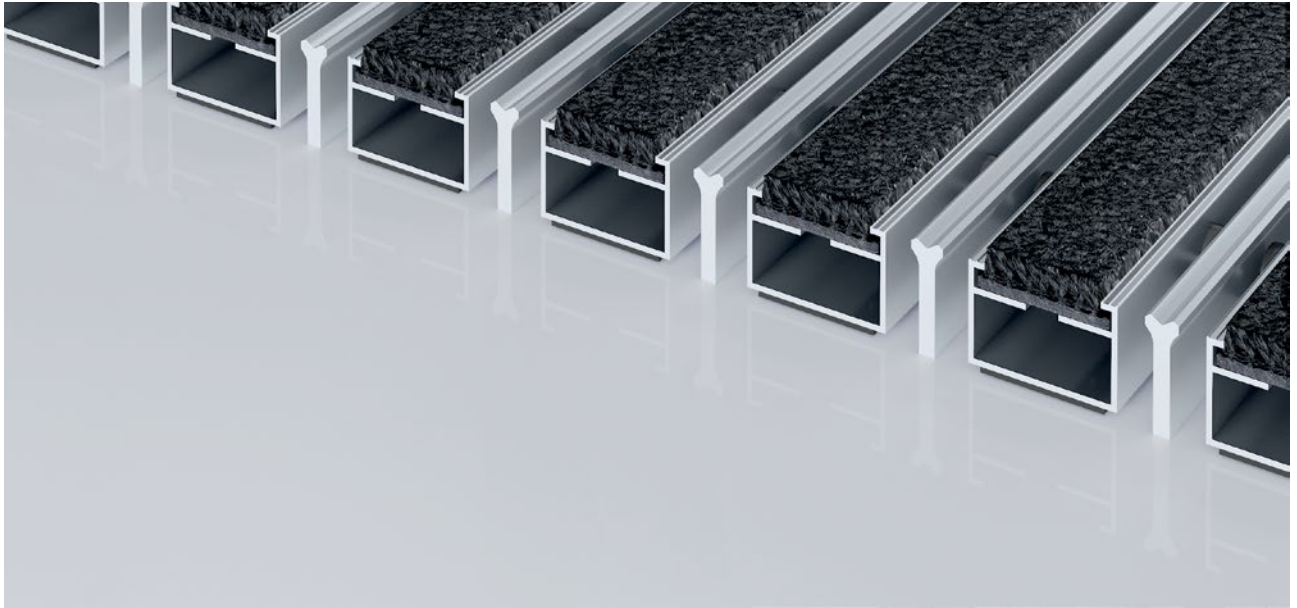

The premium entrance mat with the Maximus Image insert for single-colour printing of individual colour preferences is the number-one choice for environments that call for a unique design and exceptional reduction of fine dirt. Optimally designed for buildings exposed to average to heavy footfall.

1 **2** **3** Indoor and outdoor (covered, Zone 1+2)

Description

Rollable and hard-wearing premium entrance mat with performance insert for supported installation options. Suitable for single-colour printing of individual colour preferences. Customisable widths and walking depths available without a compensation profile. Available in any geometric shape.



Indoor and outdoor (covered, Zone 1+2)



Street dust, hair, sand, ash, textile fibres, small leaves and twigs, etc.



Damp street dust, damp sand deposits, dust, etc.



5 years guarantee















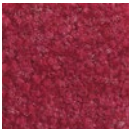



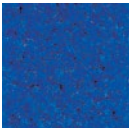

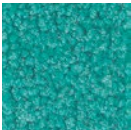
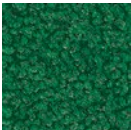
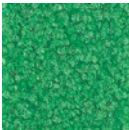
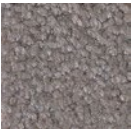

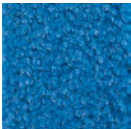

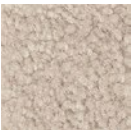

class 33 (heavy commercial use)

emco DIPLOMAT Premium With Maximus Image insert and scraping edge

Model 517 P Maximus Image K

Colours

							
I10 Lemon	I20 Yellow	I30 Yellow/ orange	I40 Orange	I50 Terracotta	I60 Red	I70 Oxide red	I80 Bordeaux
							
I90 Light red	I100 Cherry	I110 Purple	I120 Lilac	I130 Grape	I140 Magenta	I150 Peach	I160 Royal blue
							
I170 Light blue	I180 Petrol blue	I190 Emerald green	I200 Marine blue	I210 Dark green	I220 Mint	I230 Leaf green	I240 Reed green
							
I250 Green	I260 Brown	I270 Graphite	I280 Steel blue	I290 Light blue	I300 Silver	I310 Fawn brown	I320 Sand
							
I330 Chestnut	I340 Grey beige	I350 Blue grey	I360 Light grey	I370 Grey	I380 Dark grey	I390 Black	I400 White*
							
I410 Steel grey	I420 Gold	I430 Salmon pink	I440 Light green	I450 Sunset			

emco DIPLOMAT Premium With Maximus Image insert and scraping edge

Model 517 P Maximus Image K

Approx. height (mm)	17
Roll-over and drive-over capability:	Prams Sack-/hand truck Wheelchairs
Standard profile clearance approx. (mm)	5 mm, rubber spacers
Automatic door systems	Profile clearance of 3 mm available as an option for revolving door drives, in accordance with EN 16005
Connection	Plastic-coated steel cable
Max. width/profile length for individual section (mm):	3000
Profile width (mm)	27.5
Weight (kg/m²)	10,3
Mat division as per factory standards	From a profile length of 3000 mm or a maximum mat weight of 30 kg. For profile lengths above 2300 mm, a surcharge is applicable. Mat deviations/splits possible at customer's request.
Support chassis	Made using rigid aluminium with Premium sound absorbing insulation on the underside
Support chassis colour	Aluminium as standard. Anodised colours for an additional charge: EV3 gold, C33 mid-bronze, C35 black or C31 stainless steel
Tread surface	The Maximus Image insert is suitable for single-colour printing in a personally chosen colour. The additional profile increases the cleaning effect.
Flammability	Insert with fire classification Bfl-s1 according to EN 13501.
Pile material	100% PA 6.6 (polyamide)
Use classification EN1307	class 33 (heavy commercial use)

Accessories
emco installation frame 500: 500-20 AL Aluminium
emco installation frame 500: 500-20 CN Chrome-nickel steel (V2A)
emco ramp edge: A17 Aluminium
emco T-profile: T17
emco cover strip: C17 Chrome-nickel steel (V2A)
emco INOX®: LINEO 17 Chrome-nickel steel (V2A)
emco INOX®: QUADRO 17 Chrome-nickel steel (V2A)
emco dirt collection well: 5517AL Aluminium
emco dirt collection well: 5517CN Chrome-nickel steel (V2A)
emco dirt collection well: 5517AL Aluminium
emco dirt collection well: 5517CN Chrome-nickel steel (V2A)
Rubber underlay 3 mm: GU 3
Rubber underlay 5 mm: GU 5
Rubber underlay 1 mm: GU 1
Mat joining brackets: MV Supplied as standard with mats in several parts

Suitable for:
Retirement homes and Care-/Nursery Homes
medical practice
Offices and administrative buildings
Family home
Retail sector
Hotel
Kindergarten/Nursery
Apartment building
School
Sports hall

Insert certified to TÜV PROFiCERT- product interior (Standard)
French VOC regulation
LEED v4 (outside North America)
BREEAM Exemplary Level
Belgian VOC regulation
AgBB (Committee for Health-related Evaluation of Building Products)
MVV TB Appendix 8, 9 / ABG

emco DIPLOMAT Premium With Maximus Image insert and scraping edge

Model 517 P Maximus Image K

Service and services

Construction site advice

Dimensioning

Measured using laser measuring device on site.

Installation service

Fitting and installation service

Repairs

The product can be disposed of or recycled in an environmentally friendly way.

Warranty conditions are available at:
www.emco-bau.com/en/warranty-conditions/

Subject to technical modifications

emco Bautechnik GmbH · Breslauer Straße 34 - 38 · D-49808 Lingen (Ems)
· Germany · Phone: +49 (0) 591/9140-500 · Fax: +49 (0) 591/9140-852 · Email:
bau@emco.de · www.emco-bau.com

