

# emco DIPLOMAT Premium Large With Maximus Image insert and brush strip

## Model 517 PL Maximus Image B

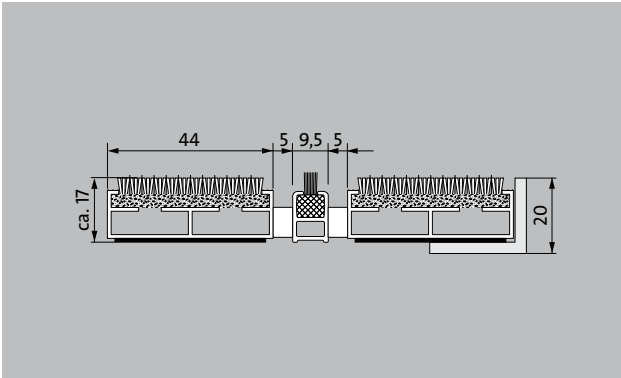
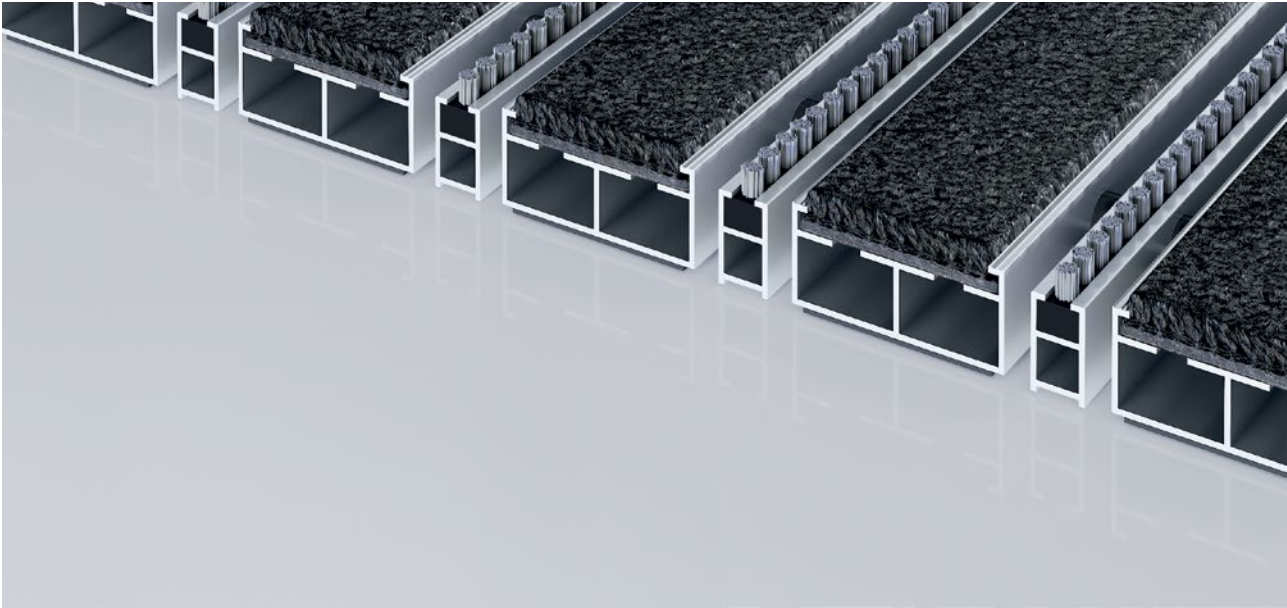

Extra-wide options for all buildings with high demands in terms of resilience and a harmonious look. Tread surface can be printed with a single-colour image.

**1** **2** **3** Indoor and outdoor (covered, Zone 1+2)

### Description

Rollable and hard-wearing premium entrance mat with extra-wide profile bars and performance insert for supported installation options. Suitable for single-colour printing of individual colour preferences. Customisable widths and walking depths available without a compensation profile. Available in any geometric shape.



Indoor and outdoor (covered, Zone 1+2)



Street dust, hair, sand, ash, textile fibres, small leaves and twigs, etc.



Damp street dust, damp sand deposits, dust, etc.



5 years guarantee



















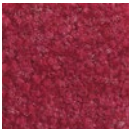







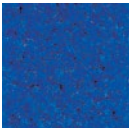

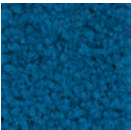

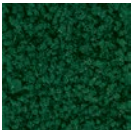
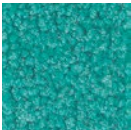
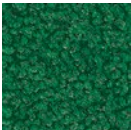
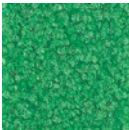
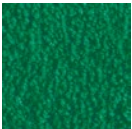

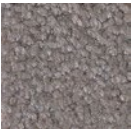

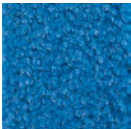



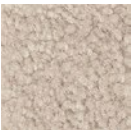

class 33 (heavy commercial use)

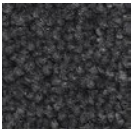

# emco DIPLOMAT Premium Large With Maximus Image insert and brush strip

## Model 517 PL Maximus Image B

**Colours**

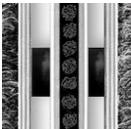
							
I10 Lemon	I20 Yellow	I30 Yellow/orange	I40 Orange	I50 Terracotta	I60 Red	I70 Oxide red	I80 Bordeaux
							
I90 Light red	I100 Cherry	I110 Purple	I120 Lilac	I130 Grape	I140 Magenta	I150 Peach	I160 Royal blue
							
I170 Light blue	I180 Petrol blue	I190 Emerald green	I200 Marine blue	I210 Dark green	I220 Mint	I230 Leaf green	I240 Reed green
							
I250 Green	I260 Brown	I270 Graphite	I280 Steel blue	I290 Light blue	I300 Silver	I310 Fawn brown	I320 Sand
							
I330 Chestnut	I340 Grey beige	I350 Blue grey	I360 Light grey	I370 Grey	I380 Dark grey	I390 Black	I400 White*
							
I410 Steel grey	I420 Gold	I430 Salmon pink	I440 Light green	I450 Sunset	grey	Black	

# emco DIPLOMAT Premium Large With Maximus Image insert and brush strip

## Model 517 PL Maximus Image B

<b>Approx. height (mm)</b>	17
<b>Roll-over and drive-over capability:</b>	Prams Sack-/hand truck Wheelchairs
<b>Standard profile clearance approx. (mm)</b>	5 mm, rubber spacers
<b>Automatic door systems</b>	Profile clearance of 3 mm available as an option for revolving door drives, in accordance with EN 16005
<b>Connection</b>	Plastic-coated steel cable
<b>Max. width/profile length for individual section (mm):</b>	3000
<b>Profile width (mm)</b>	44
<b>Weight (kg/m<sup>2</sup>)</b>	10,0
<b>Mat division as per factory standards</b>	From a profile length of 3000 mm or a maximum mat weight of 30 kg. For profile lengths above 2300 mm, a surcharge is applicable. Mat deviations/splits possible at customer's request.
<b>Support chassis</b>	Made using rigid aluminium with Premium sound absorbing insulation on the underside
<b>Support chassis colour</b>	Aluminium as standard. Anodised colours for an additional charge: EV3 gold, C33 mid-bronze, C35 black or C31 stainless steel
<b>Tread surface</b>	The Maximus Image insert is suitable for single-colour printing in a personally chosen colour. The additional profile increases the cleaning effect.
<b>Flammability</b>	Insert with fire classification Bfl-s1 according to EN 13501.
<b>Pile material</b>	100% PA 6.6 (polyamide)
<b>Use classification EN1307</b>	class 33 (heavy commercial use)

Accessories
emco installation frame 500: 500-20 AL Aluminium
emco installation frame 500: 500-20 CN Chrome-nickel steel (V2A)
emco ramp edge: A17 Aluminium
emco T-profile: T17
emco cover strip: C17 Chrome-nickel steel (V2A)
emco INOX®: LINEO 17 Chrome-nickel steel (V2A)
emco INOX®: QUADRO 17 Chrome-nickel steel (V2A)
emco dirt collection well: 5517AL Aluminium
emco dirt collection well: 5517CN Chrome-nickel steel (V2A)
emco dirt collection well: 5517AL Aluminium
emco dirt collection well: 5517CN Chrome-nickel steel (V2A)
Rubber underlay 3 mm: GU 3
Rubber underlay 5 mm: GU 5
Rubber underlay 1 mm: GU 1
Mat joining brackets: MV Supplied as standard with mats in several parts

Suitable for:
Retirement homes and Care-/Nursery Homes
medical practice
Offices and administrative buildings
Family home
Retail sector
Hotel
Kindergarten/Nursery
Apartment building
School
Sports hall

Insert certified to TÜV PROFiCERT- product interior (Standard)
French VOC regulation
LEED v4 (outside North America)
BREEAM Exemplary Level
Belgian VOC regulation
AgBB (Committee for Health-related Evaluation of Building Products)
MVV TB Appendix 8, 9 / ABG

# emco DIPLOMAT Premium Large With Maximus Image insert and brush strip

---

## Model 517 PL Maximus Image B

### Service and services

Construction site advice

Dimensioning

Measured using laser measuring device on site.

### Installation service

Fitting and installation service

Repairs

The product can be disposed of or recycled in an environmentally friendly way.

Warranty conditions are available at:  
[www.emco-bau.com/en/warranty-conditions/](http://www.emco-bau.com/en/warranty-conditions/)

Subject to technical modifications

emco Bautechnik GmbH · Breslauer Straße 34 - 38 · D-49808 Lingen (Ems)  
· Germany · Phone: +49 (0) 591/9140-500 · Fax: +49 (0) 591/9140-852 · Email:  
[bau@emco.de](mailto:bau@emco.de) · [www.emco-bau.com](http://www.emco-bau.com)

