

Model 500-25 AL

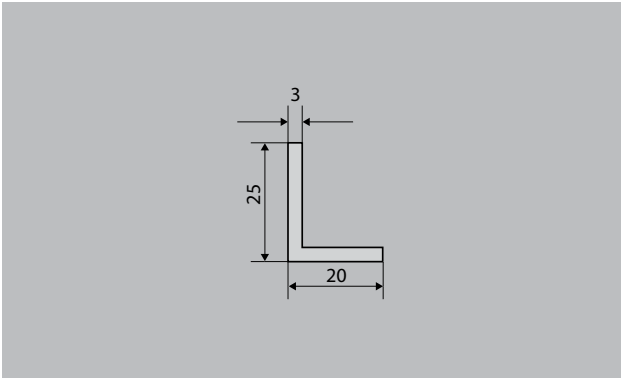

Description

The emco installation frame 500 consists of angled profiles, with mitred corners. Strong frame-connectors are supplied to ensure a precise screw connection. Wall anchors are available as an option with the delivery. The frame is supplied ready to install.

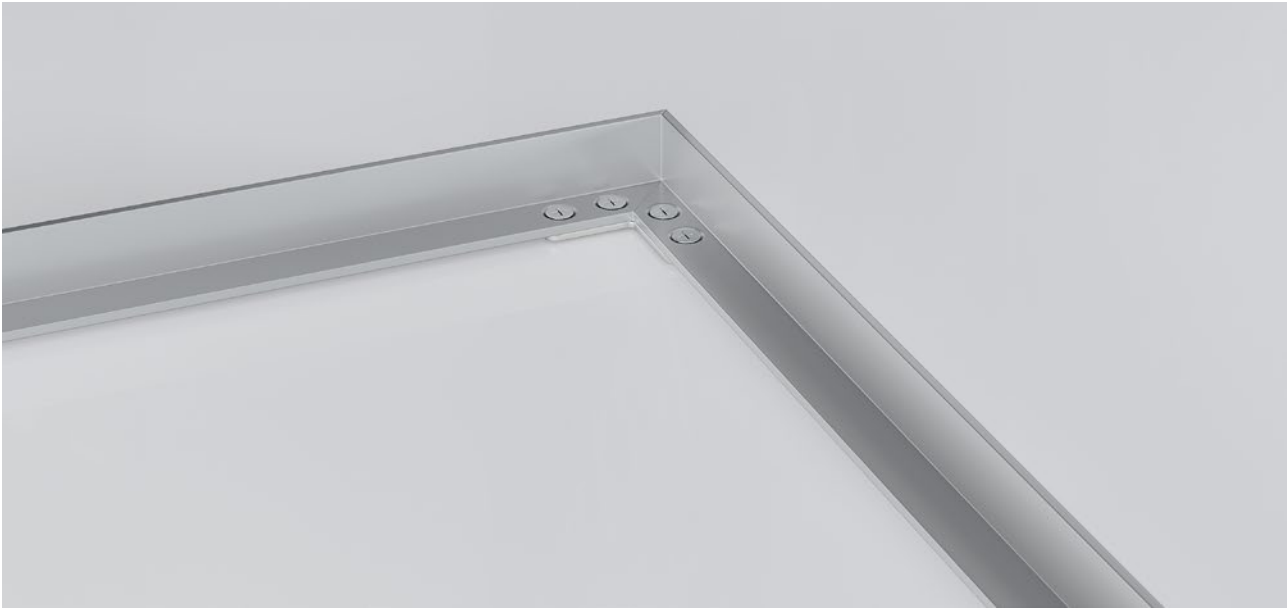

Outside (Zone 1)



Indoor and outdoor (covered, Zone 1+2)

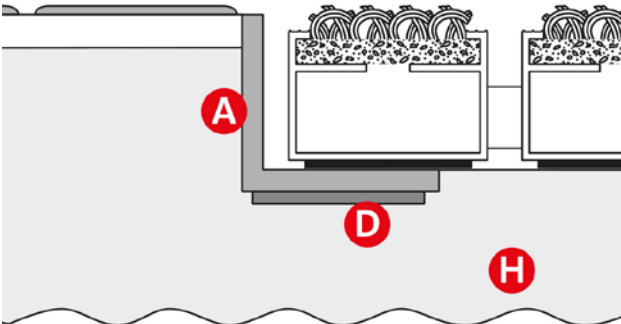
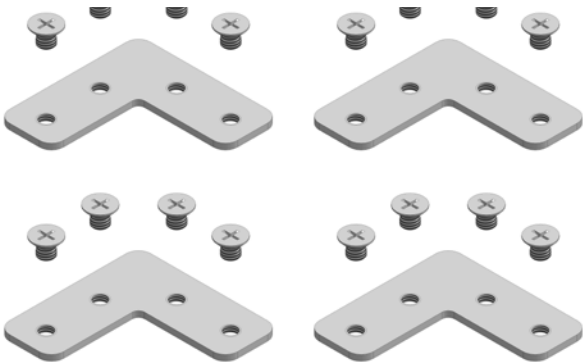

Model 500-25 AL

Approx. material thickness (mm)	3,0
Colour of frame profile	Aluminium as standard. Anodised colours for an additional charge: EV3 gold, C33 mid-bronze, C35 black or C31 stainless steel

Installation guide

The frame (A) must sit flush both with the appropriate substrate (H) in the mat well and with the indoor floor covering (J). Mat and mat well: The suitable substrate (H), for example screed, must be absolutely level (DIN 18560). If the mat well has any irregularities, these must be levelled out before inserting the mat. We recommend using a liquid levelling compound in these cases. The frame can be either glued into the mat well, fixed mechanically or firmly embedded into the appropriate substrate with the frame anchors which are available if required. It is important to ensure that the frame and the entrance mat is fully supported.

Subject to technical modifications