

Model 12 NF

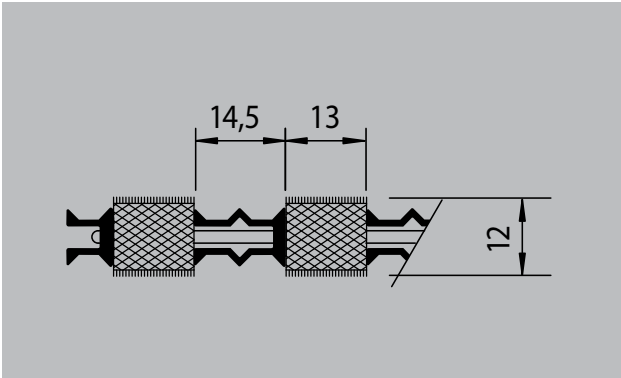
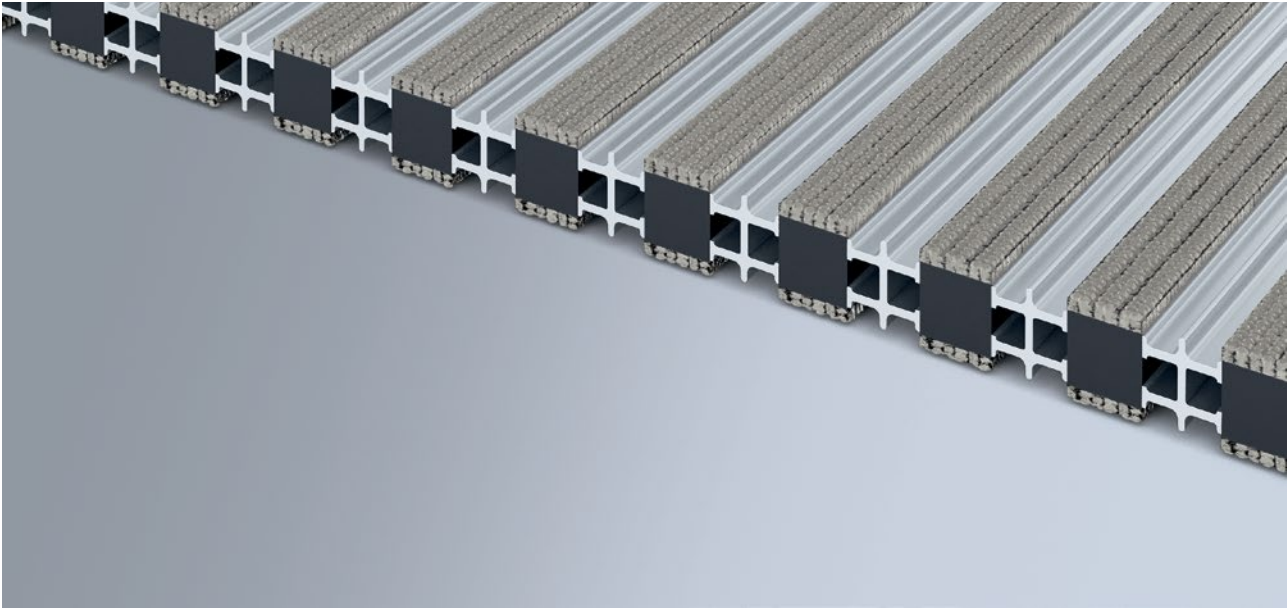

1 **2** **3** Indoor and outdoor (covered, Zone 1+2)

Description
An all-in-one, extremely hard-wearing and reversible entrance mat for laying on top of flooring. Customisable widths and walking depths available. Available in any geometric shape.

-  Indoor and outdoor (covered, Zone 1+2)
-  Street dust, hair, sand, ash, textile fibres, small leaves and twigs, etc.
-  Extremely durable
- 

emco TWINGUARD with nylon flor (NF)

Model 12 NF

Approx. height (mm)	12
Roll-over and drive-over capability:	Wheelchairs Prams Light shopping trolleys hand trolleys Cars pallet trucks
Standard profile clearance approx. (mm)	0 mm, closed system
Connection	High-strength fibres
Weight (kg/m²)	7,0
Mat division as per factory standards	from a profile length of 2000 mm, a mat walking depth of 800 mm or a maximum mat weight of 45 kg
Separator profile	Nylon-pile rubber
Colour of Scraper profile	Aluminium as standard. Anodised in EV3 gold, C33 mid-bronze, C35 black or C31 stainless steel for an additional charge

Tread surface	Robust strips of nylon-pile rubber (covered on both sides with nylon fibres) combined with aluminium scraping profiles. Alternate profiles are connected with a steel wire that finishes inside a hollow aluminium profile at both ends.
Slip resistance	Checked product: 18NF; slip-resistance R10 in accordance with DIN 51131
Flammability	Insert with fire classification Cfl-s1 according to EN 13501.

Accessories
emco installation frame 500: 500-15 AL Aluminium
emco installation frame 500: 500-15 CN Chrome-nickel steel (V2A)
emco T-profile: T12

Service and services
Construction site advice
Dimensioning

Model 12 NF

Colours



grey



black



Zebra

Subject to technical modifications/Colours may deviate due to production processes